

## Acoustic systems by Sto

# Design has never been as free

## StoSilent acoustic solutions

Requirements on reverberation time, sound distribution, or speech intelligibility change depending on how a room is used. Whereas cushioned silence is valued in offices or lobbies, in a concert hall every sound, no matter how soft, must be heard. Acoustics are influenced by various factors: the composition of floors, walls and ceilings, the ambient interior climate, the type of furniture, and the number of people. Our many years of research, experience gained from many successful projects of almost all types, and our cooperation with leading architects, tradesmen, and acoustics experts have resulted in systems that take these factors into account and optimise the acoustics of any room.

Augsburger Aktienbank AG joint stock bank, DE-Augsburg



Sto Logistics Centre, DE-Stühlingen



## Four systems for every acoustics requirement

Our four systems offer more than just the technical conditions for the best sound properties in rooms. The interaction of StoSilent with highly varied finishes and the 800 colours of the StoColor System also provide you with the freedom of design that you would like for your work.

### StoSilent Distance

Suspended acoustic panel system

### StoSilent Direct

An acoustic system that can be applied directly to a wide range of substrates.

### StoSilent Compact

Acoustic plaster for use on curves and for low room heights

### StoSilent Modular

Variable ceiling and wall elements



Discover StoSilent references at [www.stosilent.com](http://www.stosilent.com) or order the "Look & Listen Book" from your Sto adviser.

Municipal pool, DE-Viersen



Max Planck Institute, DE-Seewiesen







## StoSilent Distance

The suspended panel system

It's hard to imagine modern architecture without large, even, white surfaces. The StoSilent Distance board system also allows the seamless and sound-absorbing design of walls and ceilings, which have to be suspended, for example, to reduce the room height. The room concept is thus retained with good acoustics included.

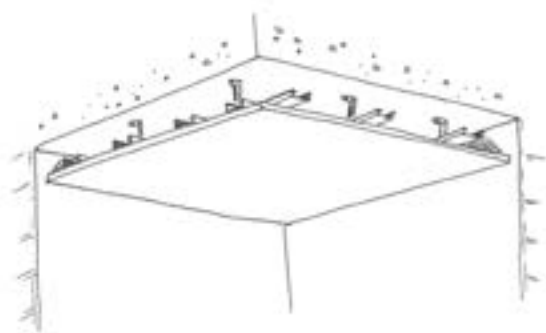

Schematic diagram of StoSilent Distance

# Seamless acoustics

## StoSilent Distance

The StoSilent Distance system can be installed as a suspended ceiling or as a wall covering with a cavity. The sub-construction is made of metal profiles and the acoustic panel consists of expanded glass granulate. The advantages of this material: it is light, absorbs sound, and can be adjusted to any shape of room to form a homogeneous, seamless surface.

### Benefits

- Seamless installation possible up to 200 m<sup>2</sup>
- Also suitable for curved surfaces and vaults
- Depending on the system variant, also suitable for damp rooms
- Conceals the mains utilities
- Perfusion safe

### Surface design

- StoSilent Top Basic: intermediate coat and finish with a fine surface
- StoSilent Top Finish: finish with a fine surface
- StoSilent Decor M: spray plaster with a textured surface
- StoSilent Decor MF: optional porous finish

You can read more about the possible surfaces and colours on page 30.

Museum MAXXI, IT-Rome



## System variants

### StoSilent Distance

Standard system with a wide spectrum of applications. Depending on the acoustic panel and the suspension height, there are different sound absorption values, from  $\alpha_w = 0.45$  for a board thickness of 15 mm to  $\alpha_w = 0.60$  for a board thickness of 25 mm. Limited combustibility in accordance with DIN EN 13501-1

### StoSilent Distance A2

The level up from StoSilent Distance. Reaches sound absorption values up to a maximum of  $\alpha_w = 0.80$ . Non-combustible in accordance with DIN EN 13501-1

### StoSilent Distance Flex

Flexible ceiling system. Flexible with a minimum radius of 5 metres, sound absorption values up to  $\alpha_w = 0.60$ . Limited combustibility in accordance with DIN EN 13501-1



StoSilent Top Basic



StoSilent Top Finish

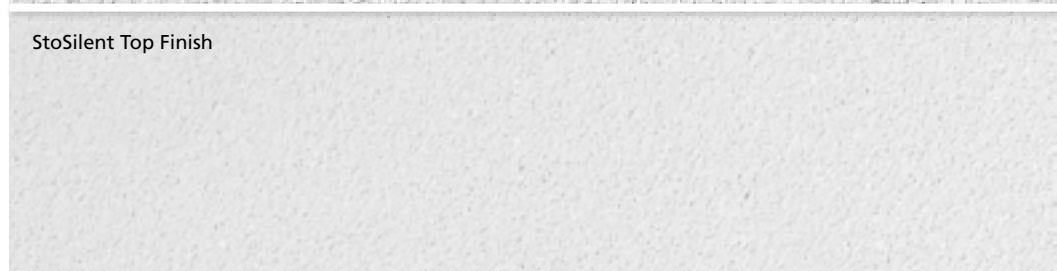

StoSilent Decor M

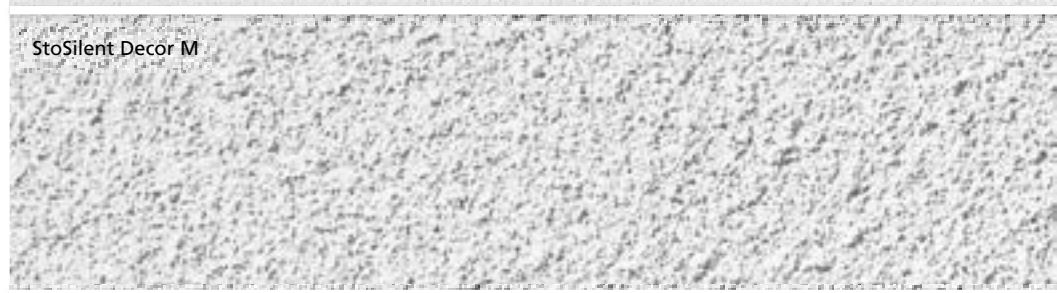

StoSilent Decor MF









**StoSilent Direct**  
The easy  
direct system

StoSilent Direct completes our range of seamless absorber solutions. The direct system does completely without a sub-construction and is suitable for walls and ceilings which can be directly coated. Sto thus offers a highly absorbent solution that is especially advisable for a small construction height. Here you also have the option of different surface finishes.

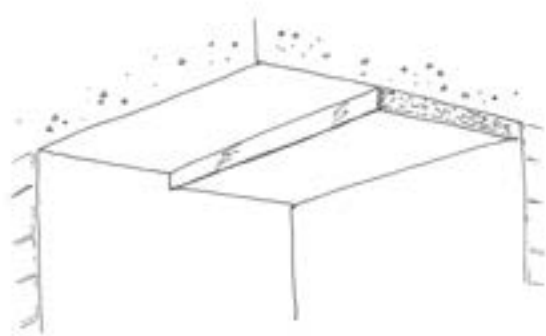

Schematic diagram of StoSilent Direct

# Impulse generator for large surfaces

## StoSilent Direct

The specialist for particularly large surfaces is based on a sandwich consisting of expanded glass granulate and stone wool, which is excellent at absorbing sound. Since it does not require a sub-construction, the system only minimally reduces the room height. The corresponding finish means you can even design seamless surfaces of up to 700 square metres.

### Benefits

- Direct bonding on to walls or ceilings
- High sound absorption due to a porous texture and sandwich structure
- Wide range of possible coatings

### Surface design

- StoSilent Top Basic: intermediate coat and finish with a fine surface
- StoSilent Top Finish: finish with a fine surface
- StoSilent Decor M: spray plaster with a textured surface
- StoColor Climasan: interior paint for surfaces with visible joints. Breaks down odours and harmful substances

You can read more about the possible surfaces and colours on page 30.



Sto Logistics Centre, DE-Stühlingen



## System variants

### Seamless systems

- StoSilent Top Basic: seamless design up to 200 m<sup>2</sup>. Depending on the system thickness, sound absorption values up to a maximum of  $\alpha_w = 0.75$ . Non-combustible in accordance with DIN EN 13501-1
- StoSilent Decor M: seamless design up to 700 m<sup>2</sup>. Depending on the system thickness, sound absorption values up to a maximum of  $\alpha_w = 0.80$ . Non-combustible in accordance with DIN EN 13501-1

### Systems with visible joints

- Climasan-System: depending on the system thickness and coating, sound absorption values up to a maximum of  $\alpha_w = 0.95$ . Non-combustible in accordance with DIN EN 130501-1 With Climasan effect



StoSilent Top Basic



StoSilent Top Finish



StoSilent Decor M

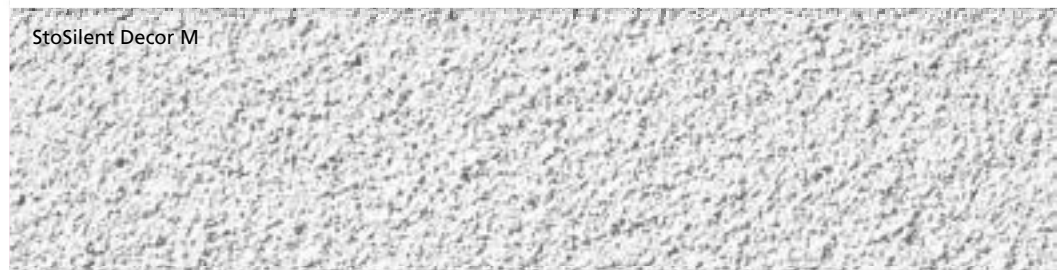

StoColor Climasan







## **StoSilent Compact** The flexible plaster system

Many structural factors do not allow suspended or mounted acoustic systems – for example, listed buildings or sacred buildings. We have developed special acoustic plasters for such cases: Our StoSilent Compact plaster systems are equally as easy to apply as classical plasters, but in addition, they positively influence room acoustics and provide a special textured appearance.

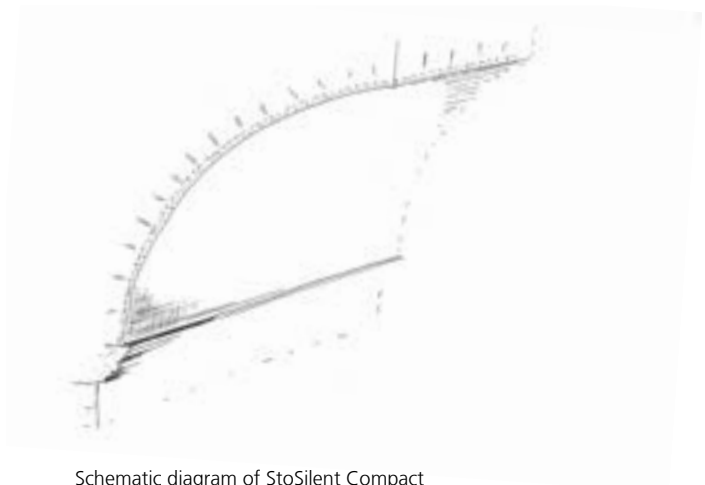

Schematic diagram of StoSilent Compact

# Audibly renders the architecture smarter

## StoSilent Compact

StoSilent Compact enables seamless, homogeneous surfaces to be quickly realised. The two plaster systems, StoSilent Compact Miral and StoSilent Compact Sil, are also highly suitable absorber solutions for multi-dimensional, curved surfaces. This means that only a minimum amount of room height is lost – highly recommended for low ceiling heights.

### Benefits

- Good room damping
- Extensive colour choice
- Coating on curves and 3D shapes possible
- Suitable for nearly all types of room

### Surface design

- StoSilent Compact Miral: acoustic plaster on a cement basis
- StoSilent Compact Sil with StoSilent Decor MF: silicate-bound acoustic plaster and textured finish

You can read more about the possible surfaces and colours on page 30.

Mediathek Oberkirch media centre, DE-Oberkirch

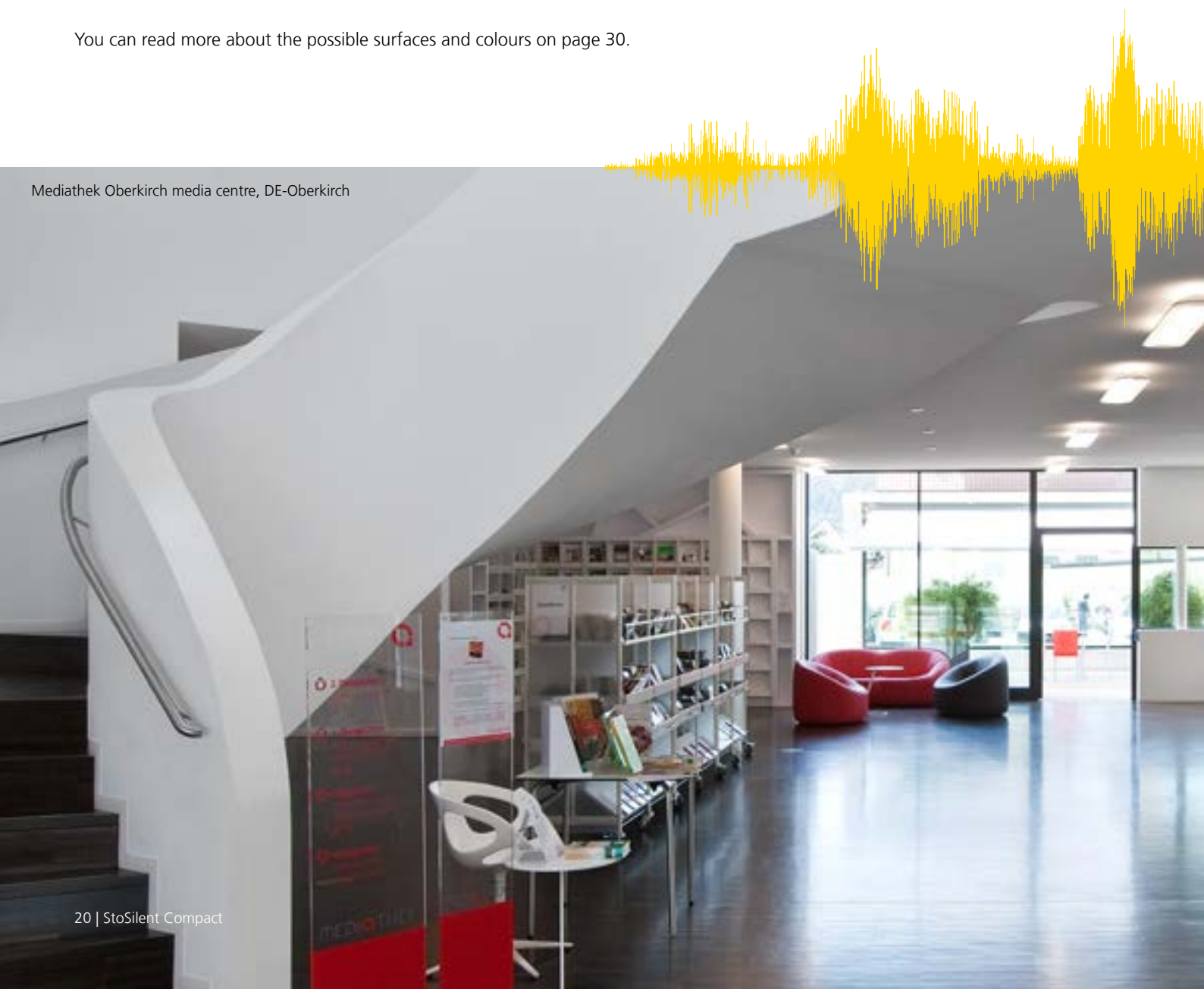

## System variants

### StoSilent Compact Miral

The mineral acoustic plaster on a cement base enables rough surfaces to be produced, ranging from level surfaces through to domes and vaults.

- Plaster application by machine
- Sound absorption up to  $\alpha_w=0.30$  (H)
- Non-combustible in accordance with DIN 13501-1
- Standard colour shade: white
- Fully tintable with the StoColor Silent finish

### StoSilent Compact Sil

The silicate-bound acoustic plaster is suitable for finely textured surfaces, such as smooth surfaces and barrel vaults.

- Manual plaster application
- Sound absorption up to  $\alpha_w=0.45$
- Limited combustibility in accordance with DIN EN 13501-1
- Standard colour shade: white
- Fully tintable with the StoSilent Decor M finish









## **StoSilent Modular** The variable ceiling system

StoSilent Modular is recommended wherever suspended or directly mounted systems are not possible, or where the acoustics need to be optimised when the room is already in use. This innovative acoustic system is so variable in form that it enables you to consciously set visual accents. Play with colours, shapes, and integrated lighting elements as you wish. StoSilent Modular provides you with all the options.

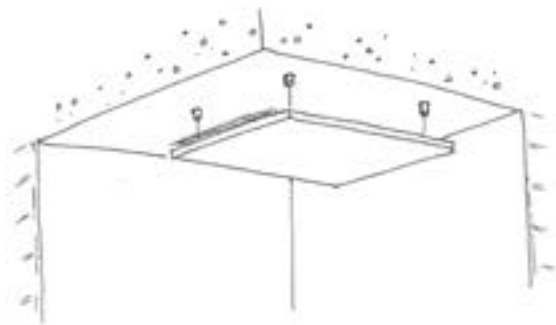

Schematic diagram of StoSilent Modular

# A good option for any location

## StoSilent Modular

We offer StoSilent Modular in three different materials: PET fibres, expanded glass granulate, and polyester fibres. These materials have special properties which demonstrate high sound absorption and thus promote good room acoustics. Whether rectangular, curved, or freeform – the ceiling elements can be realised according to your wishes.

### Benefits

- Adjusted reverberation time depending on how the room is used
- Higher speech intelligibility and lower noise level
- Function of thermally activated building elements is retained
- Special formats according to customer requirements
- Wide range of surfaces and colour design
- Quick to install and remove

### Surface design

- PET fibre nonwoven surface: fine, aligned fibre structure
- Polyester fibre nonwoven surface: fine, unaligned fibre structure
- StoSilent Top Finish: finish with a fine surface
- StoSilent Decor M: spray plaster with a textured surface
- StoSilent Decor MF: optional, fully tintable, textured finish

You can read more about the possible surfaces and colours on page 30.

Schöpf residential building, AT-Mieming



## System variants

### StoSilent Modular 100

Economical solution with an aluminium frame

### StoSilent Modular 200

Acoustic solution made of expanded glass granulate panels with a wide shape and colour spectrum



### StoSilent Modular 300

System with an ultra-thin fibre board for special design requirements

### StoSilent Modular 400

Individual solution for freely designable ceiling elements



PET fibre nonwoven surface

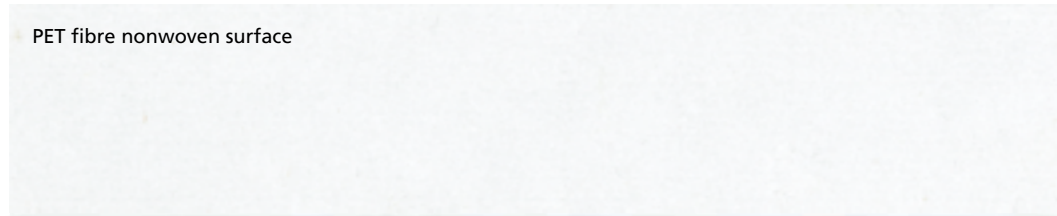

Polyester fibre nonwoven surface



StoSilent Top Finish



StoSilent Decor M

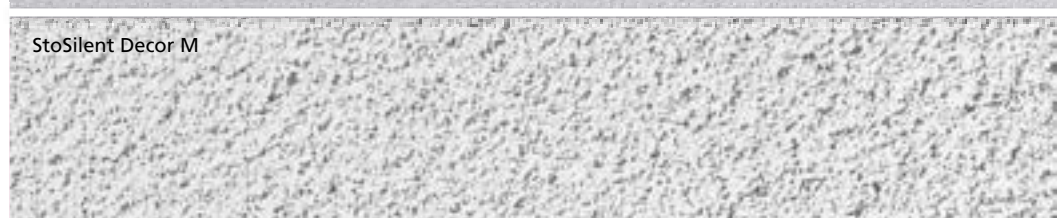

StoSilent Decor MF

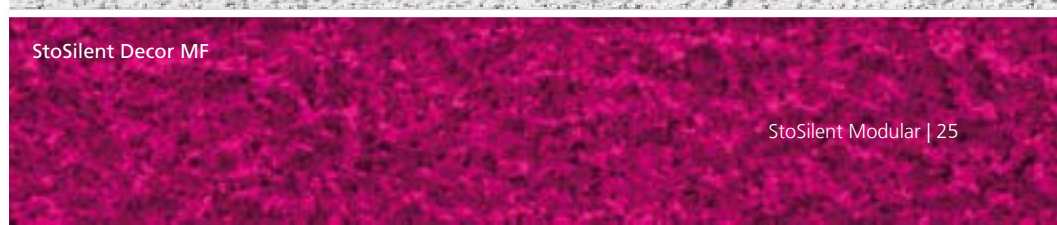

# Perfectly finished acoustics

## System variants of StoSilent Modular

We deliver modular systems as finished acoustic elements, including the load-bearing construction, mounting rim profiles, and finish. StoSilent Modular 300 meets special design requirements: the slim absorbing board combined with a thick aluminium edge, measuring only three millimetres, gives the system an elegant appearance.

### StoSilent Modular 100



The economical solution consists of PET nonwoven fibre panels and anodised aluminium frames, which are primarily used to regulate reverberations and reduce noise in buildings. StoSilent Modular 100 does more than just meet the customary market requirements for technical sound protection. Thanks to the appealing surface and the high-quality frame, the solution sets standards in design.

#### Benefits

- Low weight
- High quality, fine nonwoven surface
- Colour shade white
- Approx. 26 mm frame height
- Recycled material
- Oeko-Tex® certificate for the absorbing material
- Anodised surface
- Available up to formats of 3.00 m x 1.25 m
- Three suspended variants (vernier hanger, threaded rod, steel wire)

### StoSilent Modular 200



The acoustic solution consists of expanded glass granulate boards and the finish. StoSilent Modular 200 enables almost any shape and colour to be realised up to formats of 2.40 m x 1.20.

#### Benefits

- Low weight
- Plaster-coated
- 17 mm thick absorbing board with a foam layer
- Expanded glass granulate recycled material
- High-quality suspension set
- StoSilent Top coating for StoSilent Modular 200
- StoSilent Decor coating for StoSilent Modular 210



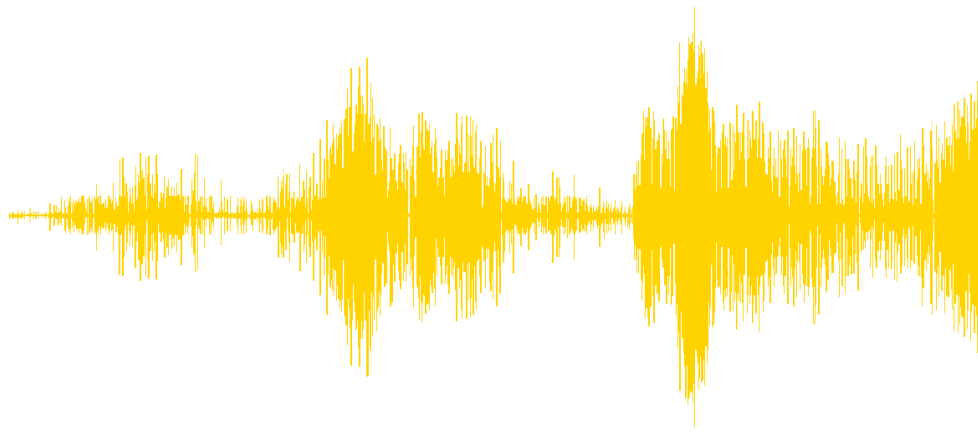

### StoSilent Modular 300

DESIGN  
CONCEPT  
AVAILABLE  
FROM 2016



The slim, polyester fibre board, measuring just eight millimetres, has a high-quality haptic surface, is highly absorbent and is recommended for rooms with high demands, such as executive offices or conference rooms, but also for restaurants. Thanks to the special construction of the aluminium carrier frame, the element can be fixed to walls or ceilings. A three-millimetre, thin, visible profile edge elegantly completes the element.

#### Benefits

- Low weight
- High quality, multi-functional carrier profile
- Installation also as wall panel
- Minimal design solution with full functionality
- Wide range of colour shades available
- Particularly suitable as "acoustic furniture"

### StoSilent Modular 400



StoSilent Modular 400 offers an unlimited range of shapes: the system can be custom-made on the construction site according to customer requirements in practically any size.

#### Benefits

- Low weight
- Free shapes possible
- Plaster-coated with StoSilent Top or StoSilent Decor
- Expanded glass granulate recycled material
- High-quality suspension set in three versions

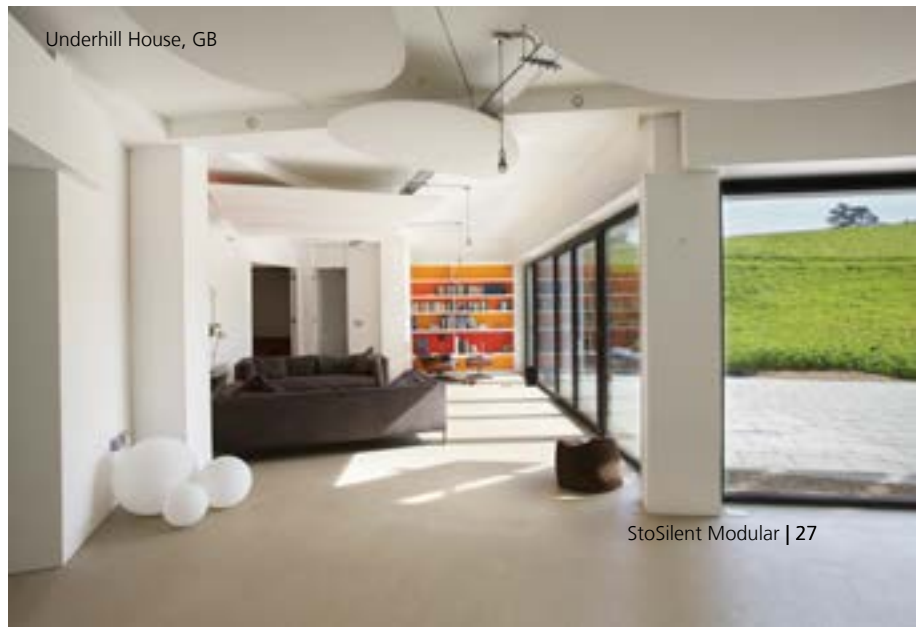

Underhill House, GB

# Colours hit the right note

## Plasters and paints for StoSilent

What would an architectonic design be without an extensive colour range? We offer the matching coatings in a wide range of colours for all our acoustic solutions. That not only means always having the right room acoustics solution for the room to be designed, but also something that is especially important in architecture: freedom.

The entire colour range of StoSilent can be found at [www.stosilent.com](http://www.stosilent.com)



## StoSilent coatings

### StoSilent Decor



With the thin-layer spray plaster, almost all StoSilent acoustic systems can be coated by machine. The colour design is practically unlimited.

- StoSilent Decor M: textured, silicate-bound coating, low-emission, eco-certified (natureplus®)
- StoSilent Decor MF: an optional finish on a dispersion base

### StoSilent Top

This finish on a dispersion base makes the finest surfaces possible. StoSilent Top is suitable for seamless application by hand up to 200 square metres. A limited colour choice is available for coating.

- StoSilent Top Basic: intermediate coat and finish with a fine surface
- StoSilent Top Finish: finish with a fine surface

## StoSilent paints

### StoColor Silent

This renovation paint was specially developed for the StoSilent acoustic systems.

- Tintable in the entire Sto colour spectrum
- Depending on the finish, the selection of colours is limited to pastel colour shades (particularly for silicate paints)

### StoColor Climasan

The colour coating gets rid of odours and breaks down harmful substances. It is the only interior paint that manages this completely without sunlight. Conventional interior lighting is sufficient to activate the catalyst in the interior paint.

- Noticeably better air, even in highly utilised rooms
- Tintable in pastel colour shades from the StoColor System







# The perfect acoustics for any room

## The StoSilent acoustic systems at a glance

### System

#### StoSilent Distance

System build-up (example)

- 1 Sub-construction made of metal profiles
- 2 Sound-absorbing acoustic panel
- 3 Self-adhesive StoSilent Profile Tape
- 4 Sound-permeable intermediate coat  
StoSilent Top Basic
- 5 Finish of StoSilent Top Finish

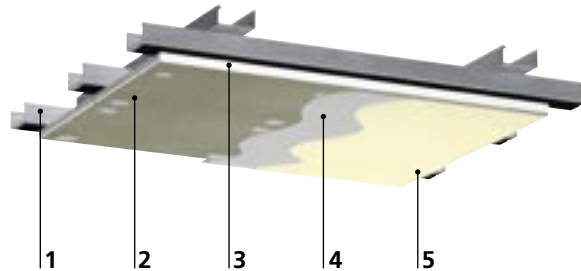

#### StoSilent Direct

System build-up (example)

- 1 Adhesive
- 2 Joint coating
- 3 Acoustic panel
- 4 Intermediate coat
- 5 Finish

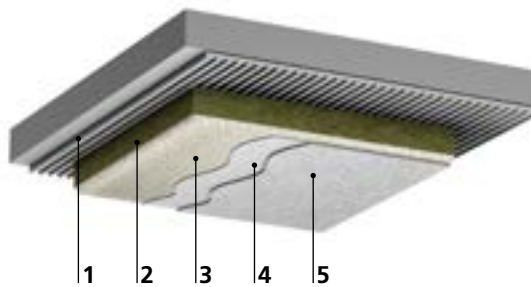

#### StoSilent Compact

System build-up (example StoSilent Compact Sil)

- 1 Prime coating
- 2 Bonding agent
- 3-5 Intermediate coat
- 6 Finish

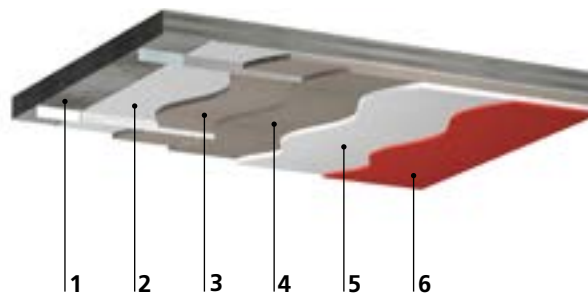

#### StoSilent Modular

System build-up (example StoSilent Modular 200)

- 1 Carrier board
- 2 Load-bearing construction
- 3 Melamine resin foam
- 4 Intermediate coat of StoSilent Top Basic
- 5 Finish of StoSilent Top Finish

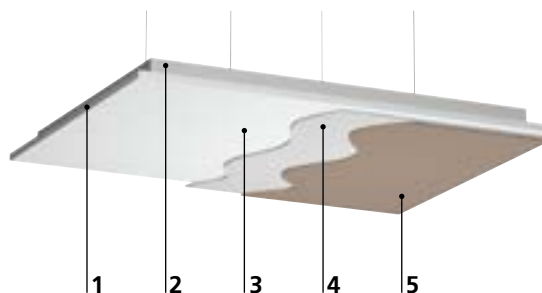

Seamless or variable, fine or rough, coloured or brilliant white: with StoSilent you can give colour and shape to room acoustics. Here you can see at a glance which is the right system for your project.

Find out more about StoSilent at [www.stosilent.com](http://www.stosilent.com)

Version	Acoustic panel	Surface	Maximum sound absorption	Building materials class	Area of application		Formability
					Ceiling	Wall	
StoSilent Distance	StoSilent Board 300	StoSilent Top	0.45–0.60	B-s1,d0	● ●	● ●	●
	StoSilent Board 310	StoSilent Decor	0.45–0.55	B-s1,d0	● ●	●	●
StoSilent Distance A2	StoSilent Board 100	StoSilent Top	0.80	A2-s1,d0	● ●	●	
	StoSilent Board 110	StoSilent Decor	0.80	A2-s1,d0	● ●	●	
	StoSilent Board 200	StoSilent Top	0.55	A2-s1,d0	● ●	●	
	StoSilent Board 210	StoSilent Decor	0.55	A2-s1,d0	● ●	●	
StoSilent Distance Flex	StoSilent Board 310 F	StoSilent Decor	0.45	B-s1,d0	● ●	●	● ●
StoSilent Direct	StoSilent Board MW 100	StoSilent Top Basic	0.75	A2-s1,d0	● ●	● ●	●
	StoSilent Board MW 100	StoSilent Decor	0.80	A2-s1,d0	● ●	● ●	●
	StoSilent Board MW 100	StoColor Climasan	0.95	A2-s1,d0	● ●	● ●	●
StoSilent Compact Sil		StoSilent Decor MF	0.45	C-s1,d0	● ●	●	● ●
StoSilent Compact Miral		StoSilent Miral AP	0.30 (H)	A2-s1,d0	● ●	●	● ●
StoSilent Modular 100	Nonwoven fibre	Nonwoven surface	Depending on suspension height, format, material, and finish	B-s1,d0	● ●	on request	
StoSilent Modular 200	Expanded glass granulate	StoSilent Top		B-s1,d0	● ●		
StoSilent Modular 210	Expanded glass granulate	StoSilent Decor		B-s1,d0	● ●		
StoSilent Modular 300	Nonwoven fibre	Nonwoven surface		B-s1,d0	● ●		
StoSilent Modular 400	Individual, on-site solution, construction based on StoSilent Board, different coating systems possible						

DESIGN CONCEPT AVAILABLE FROM 2016

● ● excellent ● good ● to a limited extent

# Look & Listen

Acoustic references from all over the world



**StoSilent**

Sets the tone  
in acoustics.

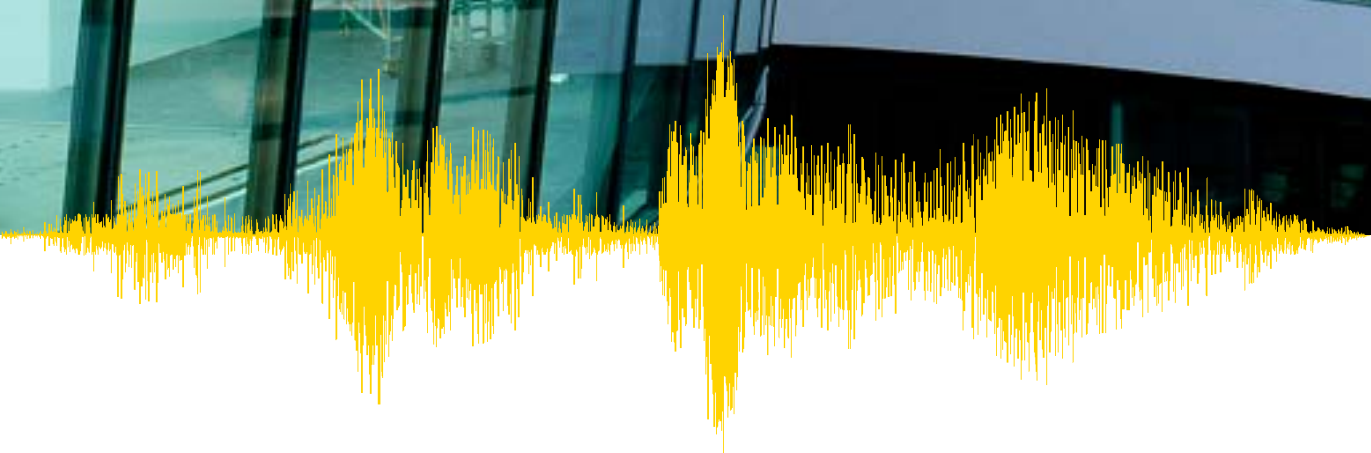



**Projekthaus, BMW Group Forschungs- und Innovationszentrum (FIZ), München, Deutschland**

Architekt: HENN

System: StoSilent Compact Sil mit Beschichtungssystem  
StoSilent Decor

**Project House, BMW Group Research & Innovation Centre (FIZ), Munich, Germany**

Architect: HENN

System: StoSilent Compact Sil with StoSilent Decor coating system



Look & Listen!



**London Metropolitan University, London, Großbritannien**

Architekt: Studio Libeskind

System: StoSilent Distance mit Beschichtungssystem

StoSilent Decor

**London Metropolitan University, London, Great Britain**

Architect: Studio Libeskind

System: StoSilent Distance with StoSilent Decor coating system







**Wohnhaus Schöpf,  
Mieming, Österreich**

Architekt: driendl\*architects

System: StoSilent Modular 400  
mit Beschichtungssystem  
StoSilent Decor

**Schöpf residential building,  
Mieming, Austria**

Architect: driendl\*architects

System: StoSilent Modular 400  
with StoSilent Decor  
coating system

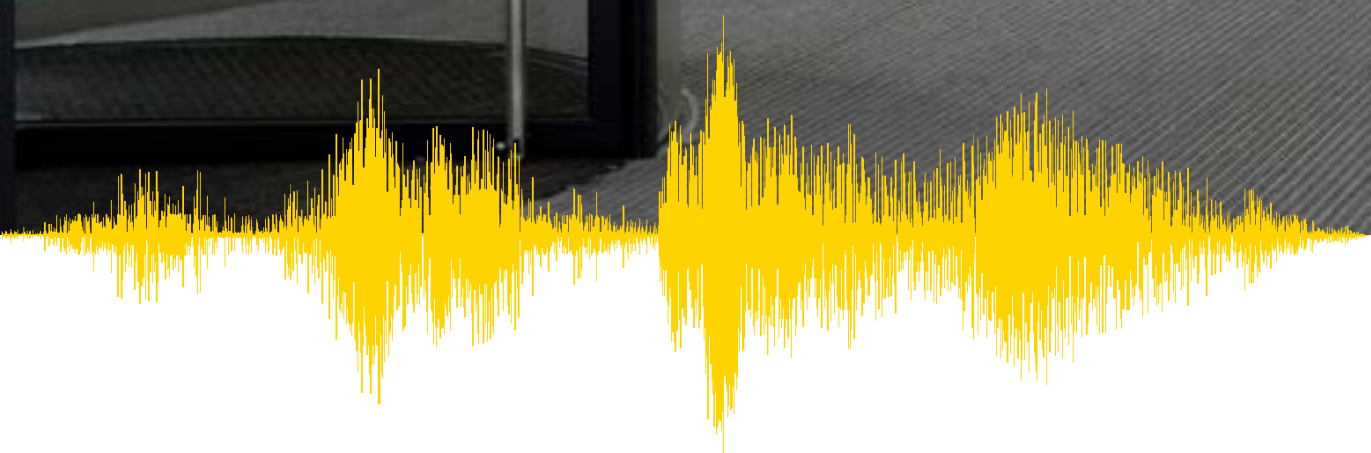



**The Walbrook, London, Großbritannien**

Architekt: Foster + Partners

System: StoSilent Distance A2 mit Beschichtungssystem  
StoSilent Top

**The Walbrook, London, Great Britain**

Architect: Foster + Partners

System: StoSilent Distance A2 with StoSilent Top  
coating system

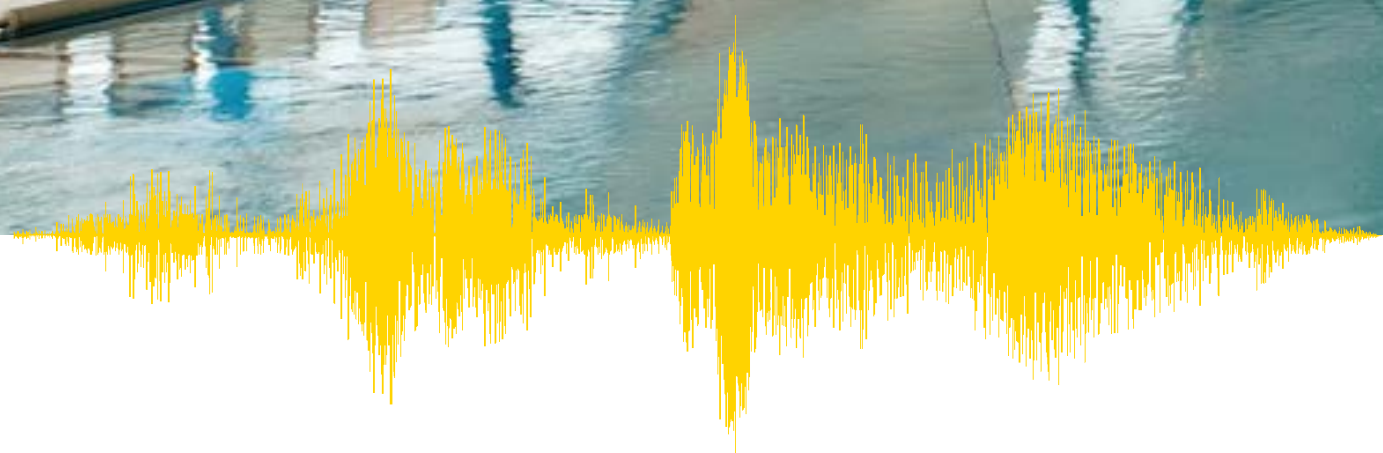



**Kärnten Therme, Warmbad-Villach, Österreich**

Architekt: Pernthaler ZT GmbH

System: StoSilent Distance mit Beschichtungssystem  
StoSilent Decor

**Kärnten Therme thermal spa, Warmbad-Villach, Austria**

Architect: Pernthaler ZT GmbH

System: StoSilent Distance with StoSilent Decor coating system





**Internationales Kongress-  
zentrum, Dalian, China**

Architekt: Shenzhen Jiang  
Feng Design

System: StoSilent Distance  
mit Beschichtungssystem  
StoSilent Decor

**Dalian International  
Conference Center,  
Dalian, China**

Architect: Shenzhen Jiang  
Feng Design

System: StoSilent Distance with  
StoSilent Decor coating system







**Sogn og Fjordane  
Kunstmuseum,  
Forde, Norwegen**

Architekt: C.F. Møller, A/S

System: StoSilent Distance A2  
mit Beschichtungssystem  
StoSilent Decor

**Sogn og Fjordane  
Museum of Fine Art,  
Forde, Norway**

Architect: C.F. Møller, A/S

System: StoSilent Distance A2  
with StoSilent Decor  
coating system





**Königliches Theater,  
Amsterdam, Niederlande**

Architekt: Greiner van Goor  
Huijten Architecten BV

System: StoSilent Distance  
mit Beschichtungssystem  
StoSilent Decor

**Royal Theater Carré,  
Amsterdam, Netherlands**

Architect: Greiner van Goor  
Huijten Architecten BV

System: StoSilent Distance with  
StoSilent Decor coating system



ADAC Service

ADAC Service



**ADAC Hansa,  
Hamburg, Deutschland**  
Architekt: Störmer Murphy  
and Partners

System: StoSilent Distance A2  
mit Beschichtungssystem  
StoSilent Decor

**ADAC Hansa,  
Hamburg, Germany**  
Architect: Störmer Murphy  
and Partners

System: StoSilent Distance A2  
with StoSilent Decor  
coating system





**The Leadenhall Building („The Cheesegrater“),  
London, Großbritannien**

Architekt: Rogers Stirk Harbour + Partners

System: StoSilent Distance mit Beschichtungssystem  
StoSilent Decor

**The Leadenhall Building (“The Cheesegrater“),  
London, Great Britain**

Architect: Rogers Stirk Harbour + Partners

System: StoSilent Distance with StoSilent Decor coating system







**Geschäftsgebäude  
Xpress Business,  
Freiburg, Deutschland**

Architekt: Pfeifer Architekten,  
Christoph Kuhn Architekten

System: StoSilent Modular 200 mit  
Beschichtungssystem StoSilent Top

**Xpress Business commercial  
building, Freiburg, Germany**

Architect: Pfeifer Architekten,  
Christoph Kuhn Architekten

System: StoSilent Modular 200  
with StoSilent Top coating system